

HILTI

AI S1/4

Deutsch	de
English	en
Français	fr
Italiano	it
Español	es
Português	pt
Nederlands	nl
Dansk	da
Svenska	sv
Suomi	fi
Magyar	hu
Polski	pl
Русский	ru
Česky	cs
Slovenčina	sk
Türkçe	tr
한국어	ko
中文	cn

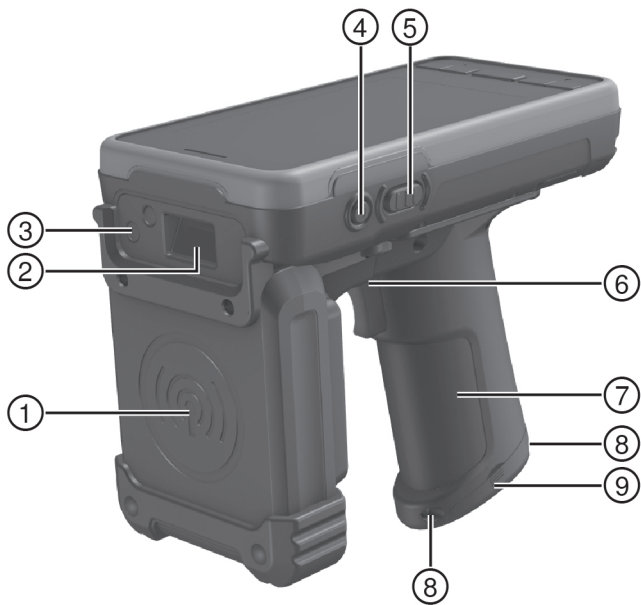



2

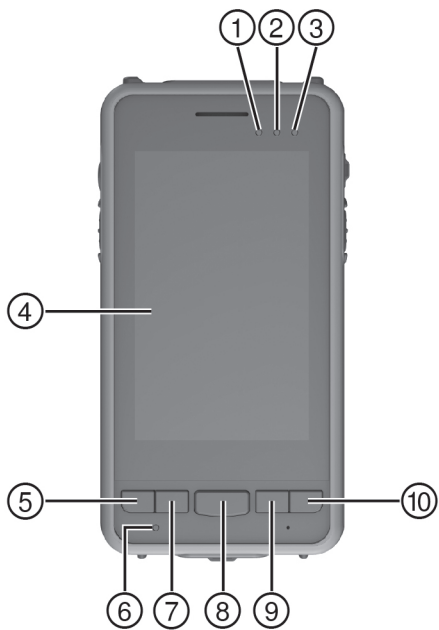

3

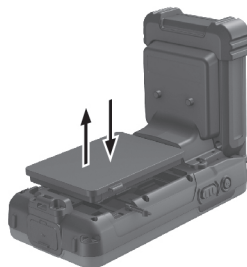

4



5



6



AI S1/4



de	Original-Bedienungsanleitung	1
en	Original operating instructions	10
fr	Mode d'emploi original	19
it	Istruzioni originali	29
es	Manual de instrucciones original	38
pt	Manual de instruções original	47
nl	Originele handleiding	56
da	Original brugsanvisning	65
sv	Originalbruksanvisning	74
fi	Alkuperäiset ohjeet	83
hu	Eredeti használati utasítás	92
pl	Oryginalna instrukcja obsługi	101
ru	Оригинальное руководство по эксплуатации	111
cs	Originální návod k obsluze	121
sk	Originálny návod na obsluhu	130
tr	Orijinal kullanım kılavuzu	139
ko	오리지널 사용설명서	148
cn	原版操作说明	157

1 Information about the documentation

1.1 Explanation of signs used

1.1.1 Warnings

Warnings alert persons to hazards that occur when handling or using the product. The following signal words are used in combination with a symbol:

	DANGER! Draws attention to imminent danger that will lead to serious personal injury or fatality.
	WARNING! Draws attention to a potentially dangerous situation that could lead to serious personal injury or fatality.
	CAUTION! Draws attention to a potentially dangerous situation that could lead to slight personal injury or damage to the equipment or other property.



1.1.2 Symbols

The following symbols are used:

	Read the operating instructions before use.
---	---

1.1.3 Illustrations

The illustrations in these operating instructions are intended to convey a basic understanding and may differ from the actual version of the product:

	The illustrations at the beginning of this documentation are numbered with these numbers; in the text in these operating instructions these numbers refer to the applicable illustration.
	Item reference numbers are used in the overview illustration. In the product overview section, the numbers shown in the legend relate to these item reference numbers.

1.2 About this documentation

- ▶ It is essential that the operating instructions are read before initial operation.
- ▶ Always keep these operating instructions together with the device.
- ▶ Ensure that the operating instructions are with the device when it is given to other persons.

Changes and errors excepted.

1.3 Product information

Hilti products are designed for professional use and may be operated, serviced and maintained only by trained, authorized personnel. This personnel must be informed of any particular hazards that may be encountered. The product and its ancillary equipment may present hazards when used incorrectly by untrained personnel or when used not as directed.

- ▶ Make a note of the designation and serial number printed on the identification plate in the following table.
- ▶ Always quote this information when you contact a Hilti representative or Hilti Service regarding questions about the product:

Product information

Type:	
Generation:	02
Serial number:	

2 Safety

2.1 Safety instructions

In addition to the safety rules listed in the individual sections of these operating instructions, the following rules must be strictly observed at all times.

2.1.1 Intended use

- ▶ To reduce the risk of injury, use only genuine **Hilti** accessories and ancillary equipment.

- ▶ **Modification of the device is not permitted.**
- ▶ **Observe the information printed in the operating instructions concerning operation, care and maintenance.**
- ▶ **Do not render safety devices ineffective and do not remove information and warning notices.**
- ▶ Check the condition of the device before use. **Do not use the device if it is damaged.** If the device is damaged, have it repaired at a **Hilti Service Center**.

2.1.2 Proper arrangement of the workplace

- ▶ **Avoid unfavorable body positions when working from ladders. Make sure you work from a safe stance and stay in balance at all times.**
- ▶ **Avoid unfavorable body positions when working from ladders. Make sure you work from a safe stance and stay in balance at all times.**
- ▶ **Use the device only within its specified limits.**
- ▶ **Do not use the device where there is a risk of fire or explosion.**
- ▶ Make sure that the case is properly secured during transport and does not present a risk of injury.

2.1.3 Electromagnetic compatibility

- ▶ Although the device complies with the strict requirements of the applicable directives, **Hilti** cannot entirely rule out the possibility of interference to the device caused by powerful electromagnetic radiation, possibly leading to incorrect operation. Accuracy must be checked by taking measurements by other means when working under such conditions or if you are unsure. Likewise, **Hilti** cannot rule out the possibility of interference with other devices (e.g. aircraft navigation equipment).
- ▶ **Operation of the device in the proximity of expectant mothers or persons with a cardiac pacemaker is not permissible.**
- ▶ Never point the device toward yourself or toward the body of any other person nearby. Never operate the device in conjunction with another antenna or other transmitter.

2.1.4 General safety rules

Mechanical safety rules

- ▶ Maintain the device carefully. Check for misalignment or binding of moving parts, breakage of parts and any other condition that may affect operation of the device. If damaged, have the device repaired before use.
- ▶ **When the device is brought into a warm environment from very cold conditions, or vice-versa, allow it to become acclimatized before use.**
- ▶ **Although the device is protected against the entry of moisture, it should be wiped dry before being put away in its transport container.**
- ▶ **Have the device serviced by a qualified repair person using only identical replacement parts. This will ensure that the safety of the device is maintained.**

Electrical safety rules

- ▶ **Avoid short circuiting the battery terminals.** Check that the contacts on the battery and the device are free from foreign objects before inserting the battery. Short circuiting the battery terminals presents a risk of fire, explosion and chemical burns.
- ▶ **Do not allow moisture to enter the battery.** Moisture in the interior of the device may cause a short circuit and chemical reactions resulting in burns to the skin or fire.
- ▶ **Make sure that the outer surfaces of the battery are clean and dry before inserting it in the charger.** Observe the operating instructions for the charger.
- ▶ Remove the battery before transporting the device or before storing it for a long period of time. Inspect the battery for any signs of leakage or damage before reinserting it.
- ▶ **To avoid pollution of the environment, the device and the batteries must be disposed of in accordance with the currently applicable national regulations. Consult the manufacturer if you are unsure of how to proceed.**
- ▶ For operation of the device and for charging batteries, use only the AI E30 charging adapter or other chargers recommended by the manufacturer. There is otherwise a risk that the device may be damaged. A charger that is suitable for a certain type of battery may present a risk of fire when used with other types of battery.

Careful use of battery-powered devices

- ▶ Under abusive conditions, liquid may be ejected from the battery. **Avoid contact with the liquid. If contact accidentally occurs, flush with water. In the event of the liquid coming into contact with**

the eyes, rinse the eyes with plenty of water and consult a doctor. Liquid leaking from the battery may cause irritation or burns.

- ▶ **Do not disassemble, crush or incinerate batteries and do not subject them to temperatures over 75°C (167°F).** This presents a risk of fire, explosion or injury through contact with caustic substances.
- ▶ **Do not expose batteries to high temperatures and keep them away from fire.** There is a risk of explosion.
- ▶ **Use only batteries of the type approved for use with the applicable device.** Use of other batteries or use of the batteries for purposes for which they are not intended presents a risk of fire and explosion.
- ▶ **Never use or attempt to charge damaged batteries** (e.g. batteries with cracks, broken parts, bent or pushed-in / pulled-out contacts).
- ▶ **Paper clips, coins, keys, nails, screws and other small metal objects that could short-circuit the electrical contacts must be kept away from batteries that are not in use and away from battery chargers.** Short-circuiting the contacts on a battery or charger may cause burning injuries or start a fire.

Requirements to be met by users

- ▶ **Stay alert, watch what you are doing and use common sense when operating the device. Do not use the device while you are tired or under the influence of drugs, alcohol or medication.** A moment of inattention while operating the device may result in serious personal injury.
- ▶ **Make sure that the grip unit is securely engaged.**
- ▶ **Observe all warnings and instructions displayed by the scanner.**

Transport

- ▶ Observe the special guidelines applicable to the transport, storage and use of Li-ion batteries.

3 Description

3.1 Overview of the product 1

①	RFID reader unit	⑧	Battery compartment cover retaining screw
②	Bar code scanner module	⑨	Grip unit battery compartment cover
③	Camera	⑩	Headphone socket
④	“On/off/standby” button	⑪	Multifunction button “right”
⑤	Multifunction button “left”	⑫	USB socket for the charging cable
⑥	“Scan” trigger	⑬	Grip unit release button
⑦	Grip unit with scanner trigger		

3.2 Overview of the screen unit 2

①	Scanner battery status LED	⑥	“Reset” button
②	Mobile networks LED	⑦	“Scan” button
③	LED for Wi-Fi	⑧	“Home” button
④	Touchscreen	⑨	“Back” button
⑤	“Menu” button	⑩	“Search” button

3.3 Intended use

The product described is a scanner. It is designed to be used for the identification and management of various assets (e.g. tools and equipment) which are marked with a bar code or RFID tag.

3.4 Software functions

The scanner uses the Android operating system. Operation is basically in accordance with the familiar Android standards implemented on conventional mobile phones.

The functions of the device are made available to users in the form of apps. You are strongly advised not to install apps on the scanner which have not been certified by **Hilti**. Such apps are not supported by **Hilti** Customer Service and will be removed from the device when maintenance or a repair is carried out.

The scanner is intended for use with the **Hilti ON!Track** system solution. In order to be able to use the corresponding app, a user name and password are required. For more detailed information about **Hilti ON!Track**, please contact your local **Hilti** sales organization or visit <http://ontrack.hilti.com>.

3.5 Items supplied

AI S1/4 scanner, AI E10 grip unit, AI E20 battery for the scanner, AI E21 battery for the grip unit, AI E30 charging adapter, PDA 60 wrist strap, operating instructions.

Spare parts, consumables and accessories approved by Hilti for use with the product can be found at your local **Hilti** Center or online at: www.hilti.com

3.6 Batteries



Note

In order to ensure maximum battery lifespan, charge the batteries at room temperature. Avoid charging the batteries at temperatures outside the 0 to 45°C range.

The system is powered by a battery in the scanner and a battery in the grip unit. The battery in the grip unit powers only the RFID reader unit. The battery status indicator in Android and the status LED indicate only the status of the scanner battery. Both batteries are charged together using the charging adapter supplied. When the batteries are fully discharged, charging may take up to 10 hours.

3.7 LEDs for scanner battery status, mobile network and Wi-Fi

3.7.1 Scanner battery

Status	Meaning
Lights up red	<ul style="list-style-type: none">Batteries are charging
Flashing red light	<ul style="list-style-type: none">Scanner battery low state of charge

3.7.2 Mobile networks LED

Status	Meaning
Lights blue	<ul style="list-style-type: none">Connected to network/Wi-Fi
LED off	<ul style="list-style-type: none">Not connected

3.7.3 LED for Wi-Fi

Status	Meaning
Lights blue	<ul style="list-style-type: none">Connected to Wi-Fi
LED off	<ul style="list-style-type: none">Not connected

4 Technical data

4.1 Device

Display	4 inch WVGA TFT LCD, 480 x 800 pixels
Operating system	Based on Android
Protection class	IP 54 dust and water spray protection as per IEC 60529
Camera	CMOS, 5.0 megapixels, autofocus and flash
Weight with batteries	600 g (21.2 oz)
Weight with batteries	230 g (8.1 oz)
Bar code scanner	2D imager

4.2 RFID reader unit

Frequency range (UHF ETSI)	865 MHz ... 868 MHz
Frequency range (UHF FCC)	902 MHz ... 928 MHz
Range	0 m ... 6 m (0 ft ... 19 ft - 10 in)

HF output power	Up to 33 dBm (ERP)
Protocol	EPC Class 1 Gen 2, ISO/IEC 18000-6C

4.3 Power source

Li-ion battery for the scanner	3.7 V/2.26 Ah
Li-ion battery for the grip unit	3.7 V/4.40 Ah
Charging adapter power supply	100...240 V/50...60 Hz
Charging adapter output voltage	5 V
Charging current	2 A

4.4 Types of connection

Wi-Fi	802.11a/b/g/n
Bluetooth	V2.1 EDR
GSM/GPRS/EDGE mobile communication	<ul style="list-style-type: none"> • 850 MHz • 900 MHz • 1,800 MHz • 1,900 MHz
UMTS/HSPA+ mobile communication	<ul style="list-style-type: none"> • 850 MHz • 900 MHz • 1,900 MHz • 2,100 MHz

4.5 Ambient conditions

Operating temperature	0 °C ... 45 °C (32 °F ... 113 °F)
Storage temperature	-25 °C ... 60 °C (-13 °F ... 140 °F)
Temperature during charging	0 °C ... 45 °C (32 °F ... 113 °F)
Recommended battery storage temperature	-20 °C ... 20 °C (-4 °F ... 68 °F)

5 Before use

5.1 Assembly

5.1.1 Inserting the battery

1. Open the battery release catch.
2. Insert the battery.
3. Close the battery release catch.

5.1.2 Assembling the screen unit and grip unit

1. Press the release button before engaging the grip unit with the screen unit.
2. While keeping the release button pressed, allow the grip unit to engage with the screen unit.
3. Pull the hand strap through the eye.
4. Remove the protective foil.

5.1.3 Inserting the SIM card in the screen unit



Note

It is necessary to insert a SIM card only if the scanner is going to be used in a mobile network.

1. Remove the grip unit.

2. Open the battery release catch.
3. Remove the battery.
4. Insert the SIM card.
5. Insert the battery.
6. Close the battery release catch.
7. Fit the grip unit.

5.2 Switching on/off and to standby mode

1. To switch the scanner on, press the on/off/standby button for 3 seconds.
2. To switch the scanner off when it is in a switched-on state, press and hold the on/off/standby button until confirmation is requested in the display and then confirm this action.
3. To go from the switched-on state to standby mode, press the on/off/standby button briefly or press the home button.
4. To go from standby mode to the switched-on state, press the on/off/standby button.

5.3 Setting up the mobile network connection



Note

A SIM card is required if the scanner is to be used in a mobile network. A SIM card can be obtained from a mobile network provider.

5.3.1 Configuring the SIM card



Note

As a rule, the necessary configuration information can be read automatically from the SIM card. In this case, no input from the user is required. For other cases, the procedure to follow for manual configuration is described below.

1. On the start screen, select '**Settings**'.
2. Select '**More...**' from the '**Wireless & networks**' menu.
3. Select '**Mobile networks**' from the menu.
4. Tick the box at '**Data enabled**'.
5. Select '**Access Point Names**'.
6. Open the "Options" menu.
7. Select '**New APN**'.
8. In the '**APN**' field, type the name of the access point you have been given by the mobile network provider.
9. Save the settings.

5.4 Wi-Fi setup

1. On the start screen, select '**Settings**'.
2. Select '**Wi-Fi**'.
 - ◀ Available networks will be shown.
3. Select your network.



Note

If you wish to change the settings for a Wi-Fi connection that has already been set up, touch and hold the network symbol until the options appear.

4. Type the data that identifies the connection.

5.5 Charging the batteries

1. Connect the grip unit to the scanner so that the battery in the grip unit is also charged.
2. Open the cover over the USB socket on the screen unit.
3. Connect the USB plug of the charging adapter to the USB socket.
4. Connect the charging adapter to the electric supply.
5. When the batteries are fully charged, disconnect the charging adapter from the electric supply and from the screen unit.
6. Close the cover over the USB socket.

5.6 Software installation

Installation of the most up-to-date version of the **Hilti** applications for the device will be suggested automatically as soon as the device is connected to the Internet. The corresponding symbol will appear in the status bar on the screen. If this does not happen within 2-3 minutes, please proceed as follows:

- ▶ Check the Internet connection.
- ▶ Restart the device.
- ▶ Contact **Hilti** Service if necessary.

6 Care and maintenance

6.1 Care

6.1.1 Cleaning and drying

- ▶ Clean the device with a clean, soft cloth. If necessary, moisten the cloth slightly with pure alcohol or a little water.



Note

Use only alcohol or water for cleaning. Other liquids may damage the plastic parts.

6.2 Maintenance

- ▶ To help ensure safe and reliable operation, use only genuine Hilti spare parts and consumables. Spare parts, consumables and accessories approved by Hilti for use with the product can be found at your local **Hilti** Center or online at: www.hilti.com.

7 Transport and storage

7.1 Transport



CAUTION

Risk of injury! A defective battery may cause chemical burns (contact with caustic substances) and damage to the equipment.

- ▶ Remove the battery before storing or transporting the device.

- ▶ Use the **Hilti** packaging or packaging of equivalent quality for transporting or shipping your equipment.
- ▶ Before transporting the device it is recommended that the grip unit is detached from the scanner.

7.2 Storage

- ▶ Do not put the device into storage when wet.
- ▶ Clean and dry the device, its case and accessories before storing.
- ▶ Avoid operating and storing the equipment where it is exposed to high air humidity. This increases life expectancy.
- ▶ Before storing the device it is recommended that the grip unit is detached from the scanner.
- ▶ After long periods of storage or transport, check the device for correct operation before use.
- ▶ Observe the temperature limits when storing your equipment. This is particularly important in extreme temperature conditions and if the equipment is kept inside a motor vehicle.

8 Troubleshooting

If the trouble you are experiencing is not listed in this table or you are unable to remedy the problem by yourself, please contact **Hilti Service**.

Trouble or fault	Possible cause	Action to be taken
The scanner can't be started.	The battery in the scanner and/or grip unit is inadequately charged.	<ul style="list-style-type: none">▶ Connect the charging adapter.▶ See "Batteries" → page 13.
The battery becomes discharged after a short period of use.	The battery is old or defective, or the maximum number of charging cycles has been exceeded.	<ul style="list-style-type: none">▶ Replace the battery.

Trouble or fault	Possible cause	Action to be taken
The scanner doesn't react.	The scanner is in standby mode or is switched off.	▶ Press the on/off/standby button briefly.
	Software error.	▶ Press and hold the reset button and then press the on/off/standby button.
The scanner doesn't capture any RFID tags.	The RFID tag is damaged.	▶ Replace the RFID tag.
	The RFID tags are incompatible.	▶ Use compatible tags from Hilti .
The scanner doesn't capture any bar codes.	The bar code is dirty or damaged.	▶ Replace the bar code.
No Wi-Fi connection.	Wi-Fi has not been set up.	▶ Configure the Wi-Fi settings. → page 15
	No network reception.	▶ Change your location.
No connection to the mobile network.	No SIM card has been inserted or the mobile network has not been set up.	▶ Configure the SIM card. → page 15
	No network reception.	▶ Change your location.

9 Disposal

 Most of the materials from which **Hilti** tools and appliances are manufactured can be recycled. The materials must be correctly separated before they can be recycled. In many countries, your old tools, machines or appliances can be returned to **Hilti** for recycling. Ask **Hilti** Service or your Hilti representative for further information.

10 Manufacturer's warranty

▶ Please contact your local **Hilti** representative if you have questions about the warranty conditions.

11 FCC statement (applicable in US) / IC statement (applicable in Canada)



Note

This equipment has been tested and found to comply with the limits for a class B digital device, pursuant to part 15 of the FCC rules. These limits are designed to provide reasonable protection against harmful interference in a residential installation. This equipment generates, uses, and can radiate radio frequency energy and, if not installed and used in accordance with the instructions, may cause interference to radio communications.

However, there is no guarantee that interference will not occur in a particular installation. If this equipment does cause harmful interference to radio or television reception, which can be determined by turning the equipment off and on, the user is encouraged to try to correct the interference by taking the following measures:

- Re-orient or relocate the receiving antenna.
- Increase the separation between the equipment and receiver.
- Connect the equipment to a power outlet on a circuit different from that to which the receiver is connected.
- Consult the dealer or an experienced TV/radio technician for assistance.



Note

Changes or modifications not expressly approved by **Hilti** may restrict the user's authorization to operate the equipment.

This device is in compliance with paragraph 15 of the FCC Regulations RSS-210 of the IC Regulations.

Operation is subject to the following two conditions:

- This device shall cause no harmful interference.
- This device must accept any interference received, including interference that may cause undesired operation.

12 EC declaration of conformity

Manufacturer

Hilti Aktiengesellschaft
Feldkircherstrasse 100
9494 Schaan

Liechtenstein

We declare, on our sole responsibility, that this product complies with the following directives and standards.

Designation Scanner

Type designation AI S1/4

Generation 02

Year of design 2015

Applicable directives:

- 1999/5/EC
- 2004/108/EC (up to April 19, 2016)
- 2014/30/EU (as of April 20, 2016)
- 2006/66/EC
- 2006/95/EC (up to April 19, 2016)
- 2014/35/EU (as of April 20, 2016)
- 2011/65/EU

Applicable standards:

- EN ISO 12100
- EN 300 328-V1.8.1
- EN 300 440-2 V1.3.1
- EN 301 489-1 V1.9.2, EN 301 489-17 V2.1.1, EN 301 489-24 V1.5.1
- EN 302 208-2 V1.4.1

Technical documentation filed at:

- Electric Tools Approval Department
Hilti Entwicklungsgesellschaft mbH
Hiltistraße 6
86916 Kaufering
Germany

Schaan, 07.2015



Paolo Luccini
(Head of BA Quality & Process Management /
Business Area Electric Tools & Accessories)



Edward Przybylowicz
(Head of BU Measuring Systems / BU Measuring
Systems)



Hilti Corporation

LI-9494 Schaan

Tel.: +423/234 21 11

Fax: +423/234 29 65

www.hilti.com



2088869