

# HILTI

TE 1

Deutsch	de
English	en
Français	fr
Italiano	it
Español	es
Português	pt
Nederlands	nl
Dansk	da
Svenska	sv
Norsk	no
Suomi	fi
Ελληνικά	el
Latviešu	lv
Lietuvių	lt
Eesti	et

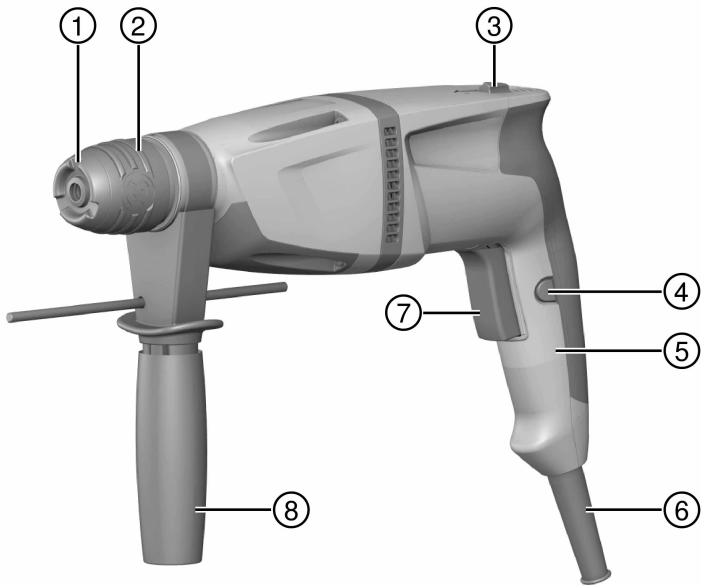



2

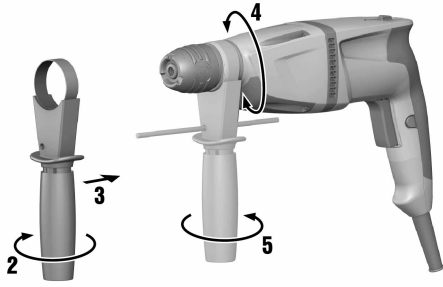
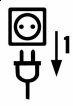

3

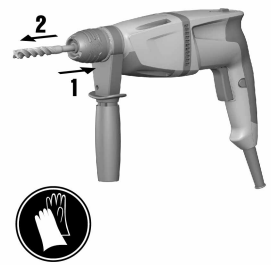
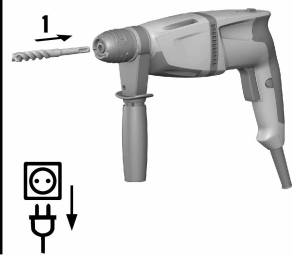
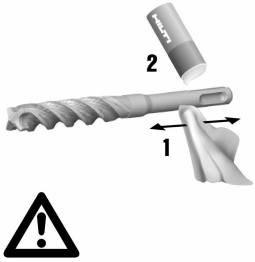

4

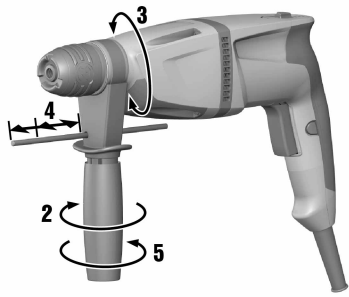
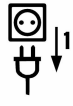

5

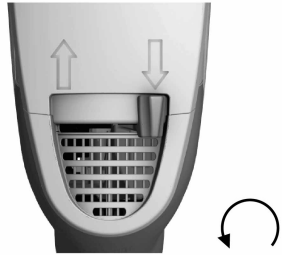
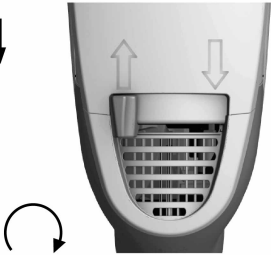
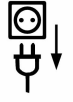

6

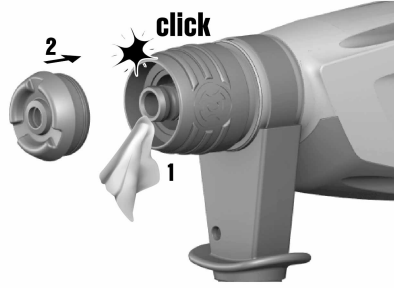
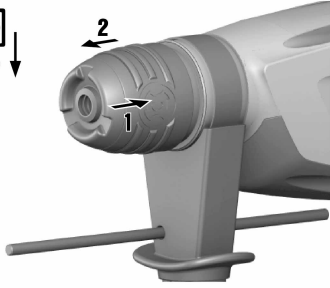

# TE 1



de	Original-Bedienungsanleitung	1
en	Original operating instructions	9
fr	Mode d'emploi original	17
it	Istruzioni originali	25
es	Manual de instrucciones original	33
pt	Manual de instruções original	41
nl	Originele handleiding	49
da	Original brugsanvisning	57
sv	Originalbruksanvisning	65
no	Original bruksanvisning	73
fi	Alkuperäiset ohjeet	80
el	Πρωτότυπες οδηγίες χρήσης	88
lv	Originālā lietošanas instrukcija	96
lt	Originali naudojimo instrukcija	104
et	Algupärane kasutusjuhend	112

## 1 Information about the documentation

### 1.1 Explanation of signs used





#### 1.1.1 Warnings

Warnings alert persons to hazards that occur when handling or using the product. The following signal words are used in combination with a symbol:

	<b>DANGER!</b> Draws attention to imminent danger that will lead to serious personal injury or fatality.
	<b>WARNING!</b> Draws attention to a potentially dangerous situation that could lead to serious personal injury or fatality.
	<b>CAUTION!</b> Draws attention to a potentially dangerous situation that could lead to slight personal injury or damage to the equipment or other property.



#### 1.1.2 Symbols

The following symbols are used:

	Read the operating instructions before use.
	Instructions for use and other useful information
/min	Revolutions per minute
RPM	Revolutions per minute
	Protection class II (double-insulated)
	Forward / reverse

#### 1.1.3 Illustrations

The illustrations in these operating instructions are intended to promote a better understanding and may deviate from the actual version of the product.

	These numbers refer to the corresponding illustrations found at the beginning of these operating instructions.
3	The numbering in the illustrations reflects the order of the work steps in the illustration and may deviate from the numbering of work steps in the text.
	Item reference numbers are used in the overview illustration. In the product overview section, the numbers shown in the legend relate to these item reference numbers.

### 1.2 About this documentation

- ▶ Read these operating instructions before the product is used or operated for the first time. This is a prerequisite for safe, trouble-free handling and use of the product.
- ▶ Observe the safety instructions and warnings printed in this documentation and on the power tool.
- ▶ Always keep the operating instructions with the power tool and make sure that the operating instructions are with it when it is given to other persons.

We reserve the right to make changes. Errors excepted.

### 1.3 Product information

Hilti products are designed for professional use and may be operated, serviced and maintained only by trained, authorized personnel. This personnel must be informed of any particular hazards that may be encountered. The product and its ancillary equipment may present hazards when used incorrectly by untrained personnel or when used not as directed.

- Make a note of the designation and serial number printed on the identification plate in the following table.
- ▶ Always quote this information when you contact a Hilti representative or Hilti Service to enquire about the product.

## Product information

Rotary hammer	TE 1
Generation	02
Serial no.	

## 2 Safety

### 2.1 Safety instructions

The safety rules given in the following section contain all general safety rules for electric tools which, in accordance with the applicable standards, require to be listed in the operating instructions. Accordingly, some of the rules listed may not be relevant to this electric tool.

#### 2.1.1 General power tool safety warnings

##### WARNING

**Read all safety warnings and all instructions.** Failure to follow the warnings and instructions may result in electric shock, fire and/or serious injury.

**Save all warnings and instructions for future reference.**

The term “power tool” in the warnings refers to your mains-operated (corded) power tool or battery-operated (cordless) power tool.

##### Work area safety

- ▶ **Keep work area clean and well lit.** Cluttered or dark areas invite accidents.
- ▶ **Do not operate power tools in explosive atmospheres, such as in the presence of flammable liquids, gases or dust.** Power tools create sparks which may ignite the dust or fumes.
- ▶ **Keep children and bystanders away while operating a power tool.** Distractions can cause you to lose control.

##### Electrical safety

- ▶ **Power tool plugs must match the outlet. Never modify the plug in any way. Do not use any adapter plugs with earthed (grounded) power tools.** Unmodified plugs and matching outlets will reduce risk of electric shock.
- ▶ **Avoid body contact with earthed or grounded surfaces, such as pipes, radiators, ranges and refrigerators.** There is an increased risk of electric shock if your body is earthed or grounded.
- ▶ **Do not expose power tools to rain or wet conditions.** Water entering a power tool will increase the risk of electric shock.
- ▶ **Do not abuse the cord. Never use the cord for carrying, pulling or unplugging the power tool. Keep cord away from heat, oil, sharp edges or moving parts.** Damaged or entangled cords increase the risk of electric shock.
- ▶ **When operating a power tool outdoors, use an extension cord suitable for outdoor use.** Use of a cord suitable for outdoor use reduces the risk of electric shock.
- ▶ **If operating a power tool in a damp location is unavoidable, use a residual current device (RCD) protected supply.** Use of an RCD reduces the risk of electric shock.

##### Personal safety

- ▶ **Stay alert, watch what you are doing and use common sense when operating a power tool. Do not use a power tool while you are tired or under the influence of drugs, alcohol or medication.** A moment of inattention while operating power tools may result in serious personal injury.
- ▶ **Use personal protective equipment. Always wear eye protection.** Protective equipment such as dust mask, non-skid safety shoes, hard hat, or hearing protection used for appropriate conditions will reduce personal injuries.
- ▶ **Prevent unintentional starting. Ensure the switch is in the off-position before connecting to power source and/or battery pack, picking up or carrying the tool.** Carrying power tools with your finger on the switch or energising power tools that have the switch on invites accidents.
- ▶ **Remove any adjusting key or wrench before turning the power tool on.** A wrench or a key left attached to a rotating part of the power tool may result in personal injury.
- ▶ **Do not overreach. Keep proper footing and balance at all times.** This enables better control of the power tool in unexpected situations.
- ▶ **Dress properly. Do not wear loose clothing or jewellery. Keep your hair, clothing and gloves away from moving parts.** Loose clothes, jewellery or long hair can be caught in moving parts.

- ▶ **If devices are provided for the connection of dust extraction and collection facilities, ensure these are connected and properly used.** Use of dust collection can reduce dust-related hazards.

#### Power tool use and care

- ▶ Do not force the power tool. Use the correct power tool for your application. The correct power tool will do the job better and safer at the rate for which it was designed.
- ▶ **Do not use the power tool if the switch does not turn it on and off.** Any power tool that cannot be controlled with the switch is dangerous and must be repaired.
- ▶ **Disconnect the plug from the power source and/or the battery pack from the power tool before making any adjustments, changing accessories, or storing power tools.** Such preventive safety measures reduce the risk of starting the power tool accidentally.
- ▶ **Store idle power tools out of the reach of children and do not allow persons unfamiliar with the power tool or these instructions to operate the power tool.** Power tools are dangerous in the hands of untrained users.
- ▶ **Maintain power tools. Check for misalignment or binding of moving parts, breakage of parts and any other condition that may affect the power tool's operation. If damaged, have the power tool repaired before use.** Many accidents are caused by poorly maintained power tools.
- ▶ **Keep cutting tools sharp and clean.** Properly maintained cutting tools with sharp cutting edges are less likely to bind and are easier to control.
- ▶ **Use the power tool, accessories and tool bits etc. in accordance with these instructions, taking into account the working conditions and the work to be performed.** Use of the power tool for operations different from those intended could result in a hazardous situation.

#### Service

- ▶ **Have your power tool serviced by a qualified repair person using only identical replacement parts.** This will ensure that the safety of the power tool is maintained.

### 2.1.2 Hammer safety warnings

- ▶ **Wear ear protectors.** Exposure to noise can cause hearing loss.
- ▶ **Use auxiliary handles, if supplied with the tool.** Loss of control can cause personal injury.
- ▶ **Hold power tool by insulated gripping surfaces, when performing an operation where the cutting accessory may contact hidden wiring or its own cord.** Cutting accessory contacting a "live" wire may make exposed metal parts of the power tool "live" and could give the operator an electric shock.

### 2.1.3 Additional safety instructions

#### Personal safety

- ▶ **Modification of the power tool is not permitted.**
- ▶ **Keep the grips dry, clean and free from oil and grease.**
- ▶ **Check that the side handle is fitted correctly and tightened securely.**
- ▶ **Wear a dust mask.**
- ▶ **Improve the blood circulation in your fingers by relaxing your hands and exercising your fingers during breaks between working.**
- ▶ **The power tool is not intended for use by debilitated persons who have received no special training.**
- ▶ **Keep the power tool out of reach of children.**
- ▶ **Avoid touching rotating parts. Switch the power tool on only after bringing it into position at the workpiece.** Touching rotating parts, especially rotating drill bits or other accessories, may lead to injury.
- ▶ **Always lead the supply cord and extension cord away from the power tool to the rear while working.** This helps to avoid tripping over the cord while working.
- ▶ Dust from materials, such as paint containing lead, some wood species, concrete / masonry / stone containing silica, and minerals as well as metal, may be harmful. Contact with or inhalation of the dust may cause allergic reactions and/or respiratory or other diseases to the operator or bystanders. Certain kinds of dust are classified as carcinogenic such as oak and beech dust, especially in conjunction with additives for wood conditioning (chromate, wood preservative). Material containing asbestos may be handled only by specialists. **Use a dust removal system whenever possible. To achieve a high level of dust collection, use a suitable vacuum cleaner. When indicated, wear a respirator appropriate for the type of dust generated. Ensure that the workplace is well ventilated. Follow national requirements for the materials you want to work with.**

#### Careful handling and use of power tools

- ▶ **Secure the workpiece. Use clamps or a vice to secure the workpiece.** The workpiece is thus held more securely than by hand and both hands remain free to operate the power tool.



- ▶ **Ensure that the accessory tools used have a mounting system that is compatible with the electric tool and that they are secured in the chuck correctly.**
- ▶ **In the event of a power failure or interruption in the electric supply, switch the power tool off, unplug the supply cord and release the switch lockbutton (if applicable).** This will prevent accidental restarting when the electric power returns.
- ▶ **Avoid applying an excessive amount of grease to the drill bit connection end.** Grease may otherwise be forced out of the chuck when the power tool is in operation.

#### Electrical safety

- ▶ **Before beginning work, check the working area (e.g. using a metal detector) to ensure that no concealed electric cables or gas and water pipes are present.** External metal parts of the power tool may become live, for example, when an electric cable is damaged accidentally. This presents a serious risk of electric shock.
- ▶ **Check the power tool's supply cord at regular intervals and have it replaced by a qualified specialist if found to be damaged. If the power tool's supply cord is damaged it must be replaced with a specially-prepared and approved supply cord available from Hilti Customer Service. Check extension cords at regular intervals and replace them if found to be damaged. Do not touch the supply cord or extension cord if it is damaged while working. Disconnect the supply cord plug from the power outlet.** Damaged supply cords or extension cords present a risk of electric shock.
- ▶ **Dirty or dusty power tools that have been used frequently for work on conductive materials should be checked at regular intervals at a Hilti Service Center.** Dust (especially dust from conductive materials) or dampness adhering to the surface of the power tool may, under unfavorable conditions, lead to electric shock.

#### Work area

- ▶ **Keep bystanders a safe distance away from work area. Anyone entering the work area must wear personal protective equipment.** Fragments of workpiece or of a broken accessory may fly away and cause injury beyond the immediate area of operation.
- ▶ **If the work involves breaking right through, take the appropriate safety measures at the opposite side.** Parts breaking away could fall out and / or fall down and injure other persons.

#### Personal protective equipment

- ▶ **Wear protective gloves.** The rotary hammer may get hot during use. There is a risk of injury (cutting or burning) if the accessory tool is touched while changing it.

### 3 Description

#### 3.1 Overview of the product

- |   |                                     |   |                              |
|---|-------------------------------------|---|------------------------------|
| ① | Dust shield                         | ⑤ | Grip                         |
| ② | TE-C Click chuck                    | ⑥ | Supply cord                  |
| ③ | Forward / reverse switch            | ⑦ | Control switch               |
| ④ | Lockbutton for continuous operation | ⑧ | Side handle with depth gauge |

#### 3.2 Intended use

The product described is an electrically powered rotary hammer. It is designed for drilling in concrete, masonry and natural stone.

**Hilti** products are designed for professional use and may be operated, serviced and maintained only by trained, authorized personnel. This personnel must be informed of any particular hazards that may be encountered. The product described and its ancillary equipment may present hazards when used incorrectly by untrained personnel or when used not as directed.

- ▶ The power tool may be operated only when connected to a power supply providing a voltage and frequency in compliance with the information given on its type plate.

#### 3.3 Items supplied

Rotary hammer, side handle, depth gauge, operating instructions.



#### Note

For safe, reliable operation, use only genuine Hilti spare parts and accessories. Spare parts, accessories and consumables approved by Hilti for use with this product can be found at your **Hilti** Center or at [www.hilti.com](http://www.hilti.com).

## 4 Technical data

### 4.1 Rotary hammer



#### Note

When powered by a generator or transformer, the generator or transformer's power output must be at least twice the rated input power shown on the rating plate of the electric tool. The operating voltage of the transformer or generator must always be within +5% and -15% of the rated voltage of the electric tool.

The information given applies to a rated voltage of 230 V. The data may vary in the event of deviations from the rated voltage and for country-specific versions. Please refer to the electric tool's type identification plate for details of its voltage, frequency, current and input power ratings.

	TE 1
Rated power input	650 W
Rated current input	3.0 A
Weight in accordance with EPTA procedure 01/2003	2.4 kg
Single impact energy in accordance with EPTA procedure 05/2009	1.5 J
Ø Hammer drill bits	4 mm ... 18 mm
Maximum length of the depth gauge	180 mm

### 4.2 Noise information and vibration values determined in accordance with EN 60745

The sound pressure and vibration values given in these instructions have been measured in accordance with a standardized test and may be used to compare one electric tool with another. They may be used for a preliminary assessment of exposure. The data given represents the main applications of the electric tool. However, if the electric tool is used for different applications, with different accessory tools, or is poorly maintained, the data may vary. This may significantly increase exposure over the total working period. An accurate estimation of exposure should also take into account the times when the power tool is switched off, or when it is running but not actually being used for a job. This may significantly reduce exposure over the total working period. Identify additional safety measures to protect the operator from the effects of noise and/or vibration, for example: maintenance of the electric tool and the accessories, keeping the hands warm, organization of work patterns.

#### Noise emission values determined in accordance with EN 60745

Sound (power) level ( $L_{WA}$ )	100 dB(A)
Uncertainty for the sound power level ( $K_{WA}$ )	3 dB(A)
Emission sound pressure level ( $L_{pA}$ )	89 dB(A)
Uncertainty for the sound pressure level ( $K_{pA}$ )	3 dB(A)

#### Total vibration (vector sum of three directions), measured in accordance with EN 60745-2-6

Hammer drilling in concrete ( $a_{h, HD}$ )	15 m/s <sup>2</sup>
Uncertainty for the given vibration value (K)	1.5 m/s <sup>2</sup>

## 5 Operation

### Fitting the side handle



#### CAUTION

**Risk of injury** The depth gauge, if fitted but not used, may hinder the operator.

- ▶ Remove the depth gauge from the tool.





#### CAUTION

**Risk of injury** Loss of control over the rotary hammer.

- ▶ Check that the side handle is fitted correctly and tightened securely. Check that the clamping band is engaged in the groove provided on the tool.

2

<b>Fitting / removing the accessory tool</b>		<b>3</b>
 <b>Note</b>	Use of unsuitable grease may cause damage to the product. <b>Use only the recommended grease supplied by Hilti.</b>	
<b>Adjusting the depth gauge</b>		<b>4</b>
 <b>Note</b>	Always pay attention to the maximum length of the depth gauge.	
<b>Setting forward or reverse rotation</b>		<b>5</b>
 <b>Note</b>	Do not operate the forward / reverse switch while the motor is running.	

## 6 Care of the product

-  **WARNING**  
**Electrical hazards!** Improper repairs to electrical parts may lead to serious injuries.
- ▶ Electrical parts may be repaired only by trained electrical specialists.

- ▶ **Keep the product, especially its grip surfaces, clean and free from oil and grease. Do not use cleaning agents containing silicone.**
- ▶ Never operate the product when the air vents are blocked. Clean the air vents carefully using a dry brush. Do not allow foreign objects to enter the interior of the product.
- ▶ Clean the outside of the electric tool at regular intervals with a slightly damp cloth. Do not use a spray, steam pressure cleaning equipment or running water for cleaning.
- ▶ Clean the dust shield on the chuck with a dry, clean cloth at regular intervals. Clean the sealing lip by wiping it carefully and then grease it again lightly with **Hilti** grease. It is essential that the dust shield is replaced if the sealing lip is damaged.

### 6.1 Replacing the dust shield

- ▶ Replace the dust shield.

## 7 Troubleshooting

If the trouble you are experiencing is not listed in this table or you are unable to remedy the problem by yourself, please contact **Hilti** Service.

Trouble or fault	Possible cause	Action to be taken
The power tool doesn't start.	Interruption in the electric supply.	▶ Plug in another electric tool or appliance and check whether it works.
	The carbon brushes are worn out.	▶ Have the power tool checked by a trained electrical specialist and the carbon brushes replaced if necessary.
No hammering action.	The power tool is too cold.	▶ Bring the tip of the drill bit into contact with the working surface, switch the rotary hammer on and allow it to run. If necessary, repeat the procedure until the hammering mechanism begins to operate.
The rotary hammer doesn't achieve full power.	The gauge (cross section) of the extension cord conductors is inadequate.	▶ Use an extension cord with an adequate conductor cross section.
The drill bit cannot be released.	The chuck is not pulled back fully.	▶ Pull the chuck back as far as it will go and remove the accessory tool.



Technical documentation filed at:

- Electric tools approval department  
Hilti Entwicklungsgesellschaft mbH  
Hiltistraße 6  
86916 Kaufering  
**Germany**

Schaan, 5/2015



Paolo Luccini  
(Head of BA Quality & Process Management /  
Business Area Electric Tools & Accessories)



Tassilo Deinzer  
(Executive Vice President / Business Unit Power  
Tools & Accessories)



Hilti Corporation

LI-9494 Schaan

Tel.: +423/234 21 11

Fax: +423/234 29 65

[www.hilti.com](http://www.hilti.com)



238043